

Worldwide offices

International

TADANO LTD.

International Division
4-12, Kamezawa 2-chome
Sumida-Ku, Tokyo 130-0014, Japan
Phone: +81-3-3621-7750
Fax: +81-3-3621-7785
E-mail: tdnihq@tadano.co.jp

TADANO AMERICA CORPORATION

333 Northpark Central Drive, Suite Z
Houston, Texas 77073, USA
Phone: +1-281-869-0030
Fax: +1-281-869-0040
E-mail: sales@tadano-cranes.com

TADANO LTD. Middle East Representative Office

P.O.Box 18302, LOB15-323
Jebel Ali Free Zone, Dubai, UAE
Phone: +971-4-887-1353
Fax: +971-4-887-1703
E-mail: tadano@tadano.ae

TADANO LTD. Beijing Office

Jing Guang Centre, Room 2905, Hu Jia Lou
Chao Yang Qu
Beijing, China
Phone: +86-10-6597-3210
Fax: +86-10-6597-3220
E-mail: beijing@tadano.co.jp

Europe

TADANO FAUN GmbH

Faunberg 2
91207 Lauf a. d. Pegnitz
Germany
Phone: +49-9123-955-0
Fax: +49-9123-3085
E-mail: info@tadanofaun.de

TADANO SOUTH CHINA CO. LTD.

Room 1803, 18/F Seaview Commercial
Building 21-24 Connaught Road West
Hong Kong, China
Phone: +852-2544-9310
Fax: +852-2541-5828
E-mail: hiwa@tadanosc.com

TADANO Korea Co Ltd.

302, Koram Venture Town B/D, 907-1
Daechi-Dong, Gangnam-Ku
Seoul 135-280, Korea
Phone: +82-2-714-1600
Fax: +82-2-3274-1304
E-mail: tadano@korea.com

TADANO Asia Pte Ltd.

11 Tuas View Crescent
Multico Building
Singapore 637643
Phone: +65-6863-6901
Fax: +65-6863-6902
E-mail: Tdn-crane@tadanoasia.com

TAIWAN TADANO LTD.

4F, No.50, Sung Chiang Road
Taipei
Taiwan
Phone: +886-2-2523-1388
Fax: +886-2-2523-3988

TADANO FAUN HOLLAND B.V.

Antennestraat 6
3903 LZ Veenendaal
The Netherlands
Phone: +31-318-546-700
Fax: +31-318-542-282
E-mail: info@tadano-faun.nl

Detaillierte Informationen über unsere Internationalen Händler und Service Niederlassungen finden Sie im Internet.
For detailed information about our International Distributor and Service network, please refer to our homepages.

www.tadano.co.jp + www.tadanofaun.de + www.tadanoamerica.com

Herausgeber / Publisher:

TADANO FAUN GmbH
P.O.Box 10 02 64
91205 Lauf
Germany



Maße (mm)
 Dimensions (mm)
 Dimensiones (mm)

16.00 R 25
 (445/95 R 25)

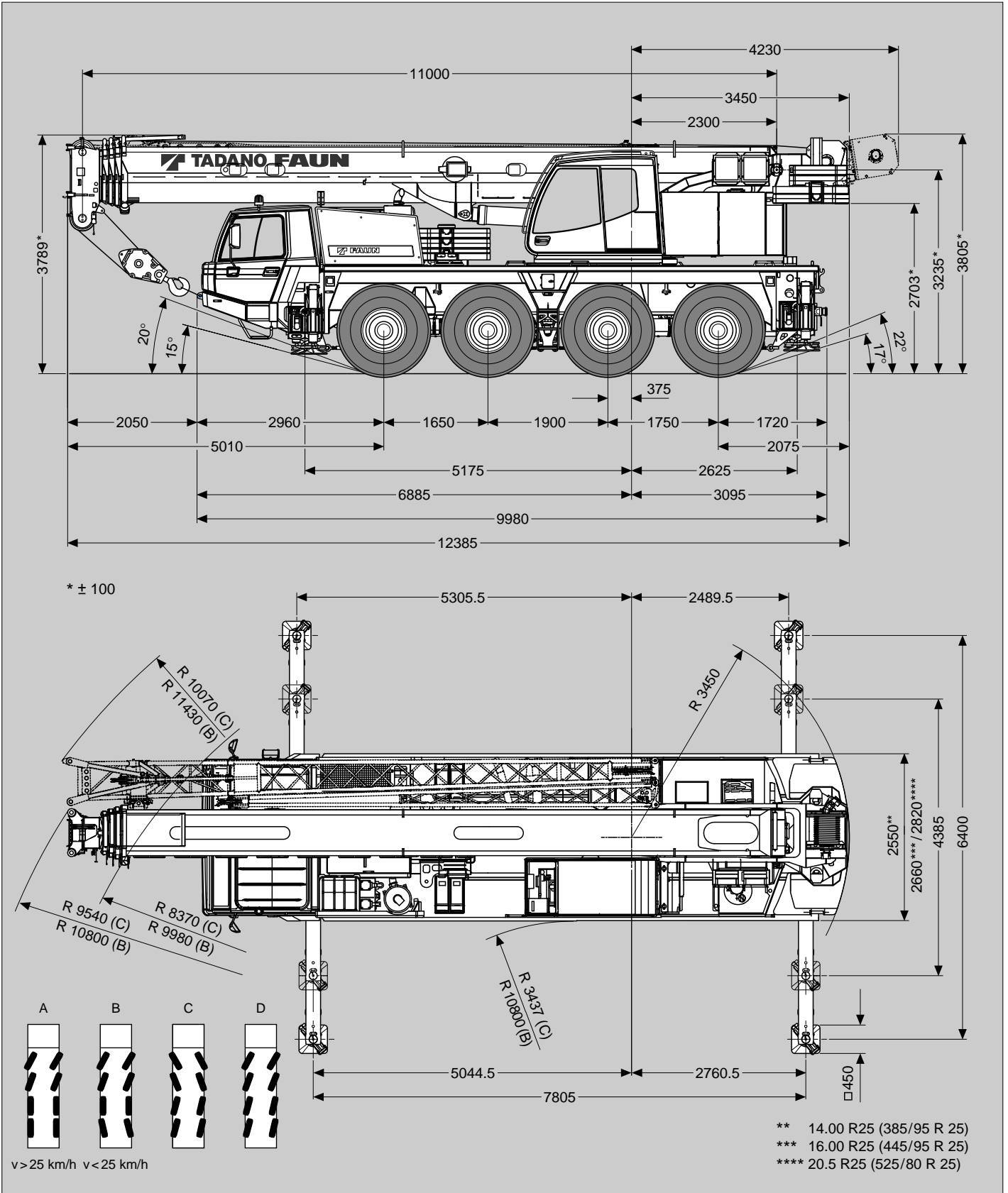

Gewichte / Geschwindigkeiten
Weights / Working speeds
Poids / Vitesses
Pesos / Velocidades de trabajo

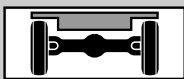
	Achse / Axle Essieu / Eje	1	2	3	4	Gesamtgewicht / Total weight Poids total / Peso total
	(t)	12	12	12	12	48*

* Incl. 12,5 t Gegengewicht, 9 m / 16 m Auslegerverlängerung, 32 t Unterflasche, 6 t Hakengeschirr, Antrieb 8 x 6, Bereifung 16.00 R 25 (445/95 R 25).



* Incl. 12.5 t counterweight, 9 m / 16 m boom extension, 32 t hook block, 6 t swivel hook, drive 8 x 6, tyres 16.00 R 25 (445/95 R 25).



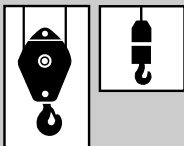



* Incl. de 12,5 t contrepoids, 9 m / 16 m flèche, 32 t moufle, 6 t élingues, entraînement 8 x 6, pneus 16.00 R 25 (445/95 R 25).

* Incl. contrapeso de 12,5 t, 9 m / 16 m plumin, 32 t gancho, 6 t gancho de bola, tracción 8 x 6, neumáticos 16.00 R 25 (445/95 R 25).

	Traglast / Lifting capacity / Force de levage / Capacidad de elevación	Rollen / Sheaves Pulies / Poleas	Stränge / Parts of line Brins / Ramales de cable	Gewicht / Weight Poid / Peso
	* Doppelhaken	50 t *	5	11
* Rams horn	50 t	5	11	475 kg
* Moufle avec crochet marin	32 t *	3	7	300 kg
* Gancho doble	32 t	3	7	300 kg
	12.5 t	1	3	170 kg
	6 t	-	1	150 kg

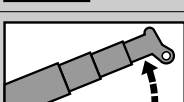

	1	2	3	4	5	6	7	8	9	10	11	12	R1	R2	
	14.00 (385/95) km/h	3	4	5	6	8	10	13	17	22	28	36	46	3	
16.00 (445/95) 20.5 (525/80) km/h	3	4	5	7	9	11	15	19	24	31	39	50	3	4	65%
	6	8	10	13	16	20	27	34	44	57	72	85	6	8	30%

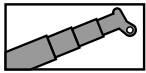

V+ 	Stufenlos Infinitely variable Progressivement variable Infinitamente variable	Seil Rope Câble Cable	Max. Seilzug Max. single line pull Effort maxi au brin simple Trio máximo por ramal
	0 - 130 m/min für einfachen Strang single line au brin simple ramal simple	16 mm / 205 m	44 kN
	0 - 65 m/min für einfachen Strang single line au brin simple ramal simple	16 mm / 205 m	44 kN
	0 - 2 min ⁻¹		
	-2° - +82° ca. 33 s approx. 33 s env. 33 s aproximadamente 33 s		
	11.0 m - 44.0 m ca. 230 s approx. 230 s env. 230 s aproximadamente 230 s		

Tragfähigkeiten
Lifting capacities
Capacités de levage
Capacidades de elevación



12.5t 'Taxi' Version

DIN/ISO/EN

 m	11.0 m	14.8 m	18.7 m	22.5 m	26.3 m	30.1 m	34.0 m	37.8 m	41.6 m	44.0 m	
2.5	65.0*										
3.0	53.8	50.0	40.0								
3.5	49.4	47.6	40.0	35.0							
4.0	45.7	44.1	40.0	34.9	30.0						
4.5	42.4	41.0	39.7	33.2	30.0	23.4					
5.0	38.3	38.2	37.0	32.0	30.0	22.2	18.5				
6.0	31.6	31.8	31.2	31.2	28.4	20.1	18.1	14.0			
7.0	26.7	27.0	27.0	26.7	26.0	18.3	16.6	14.0	10.4	9.2	
8.0	23.1	23.3	23.4	22.7	22.2	16.8	15.3	14.0	10.4	9.2	
9.0		19.5	19.6	20.3	19.2	15.4	14.1	13.1	10.4	9.2	
10.0		16.8	17.2	17.2	16.8	14.3	13.1	12.2	10.4	9.2	
11.0		14.5	14.8	14.8	14.5	13.2	12.2	11.4	10.4	9.2	
12.0		12.7	13.0	13.0	12.7	12.3	11.4	10.7	9.9	9.0	
14.0			10.2	10.2	9.9	9.6	9.6	9.4	8.9	7.8	
16.0			8.3	8.3	7.9	8.0	8.4	8.0	7.9	6.8	
18.0				7.1	6.4	7.1	6.9	6.8	6.5	6.0	
20.0				6.0	5.8	6.0	5.8	5.7	5.4	5.3	
22.0					5.0	5.0	4.9	4.8	4.5	4.5	
24.0						4.3	4.1	4.0	3.8	3.8	
26.0						3.7	3.5	3.4	3.2	3.2	
28.0							3.0	2.9	2.6	2.7	
30.0							2.6	2.5	2.2	2.2	
32.0								2.1	1.8	1.9	
34.0								1.8	1.5	1.5	
36.0									1.2	1.3	
38.0									1.0	1.0	
40.0										0.8	
 %	I	0	46/0/0/0	93/46/0/0/0/0	93/46/46/0/0	93/93/46/0	93/93/0	93/46/0	93/46	93	100
	II	0	0/46/0/0	0/46/93/46/0/0	46/93/46/46/0	93/46/46/0	93/46/46	93/46/93	93/93	93	100
	III	0	0/0/46/0	0/0/0/46/46/0	0/0/46/46/46	0/46/46/93	46/46/93	46/93/93	93/93	93	100
	IV	0	0/0/0/46	0/0/0/0/46/93	0/0/0/46/93	0/0/46/93	0/46/93	46/93/93	46/93	93	100

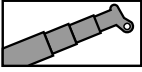

12.5t 'Taxi' Version

DIN/ISO/EN

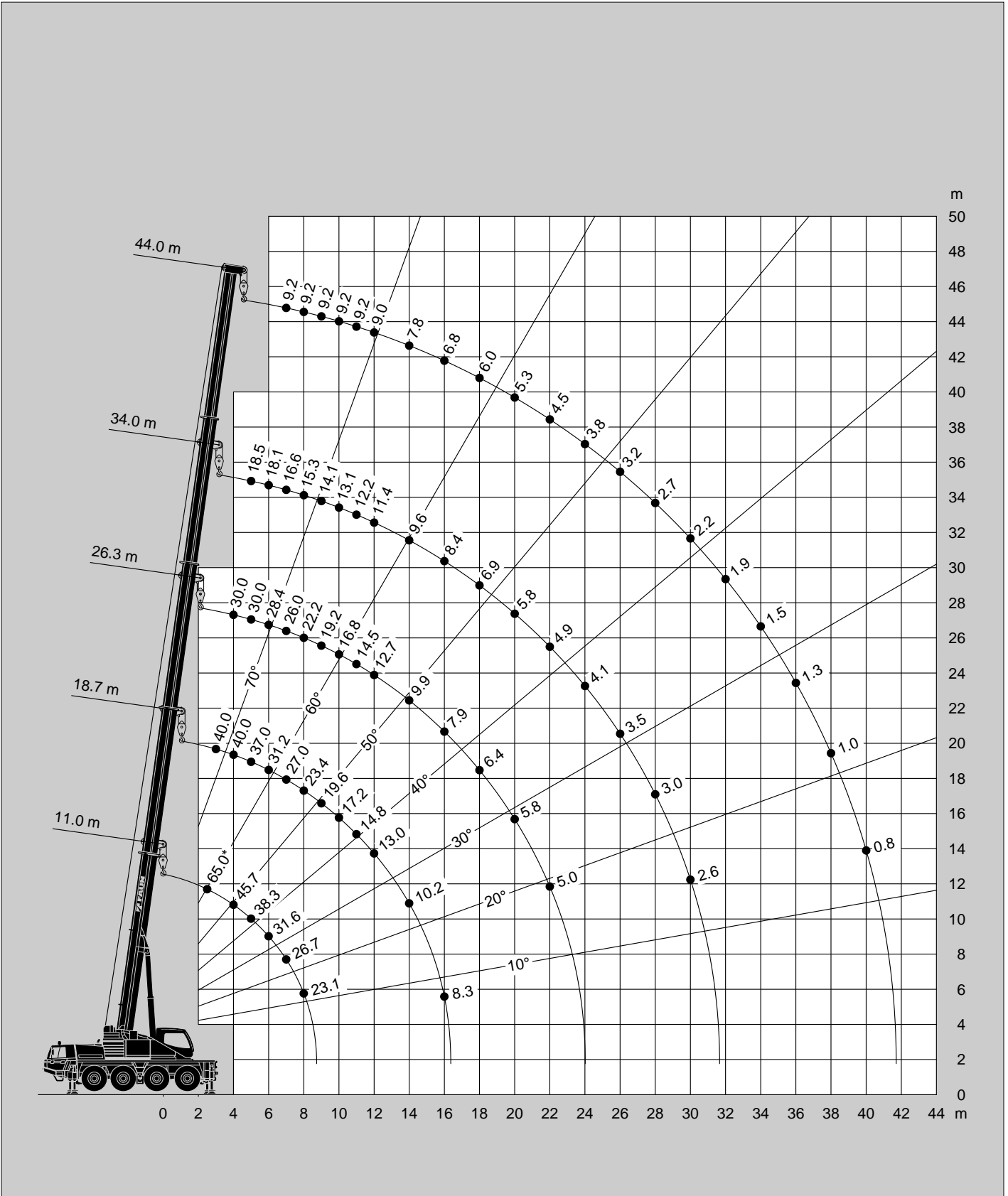

* Nach hinten mit Zusatzhubausrüstung / * Over rear with additional lifting equipment / * A l'arrière avec équipement supplémentaire / * Sobre la parte trasera con equipo adicional

Tragfähigkeiten
Lifting capacities
Capacités de levage
Capacidades de elevación

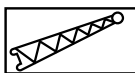
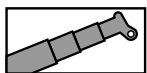

12.5t

'Taxi' Version

DIN/ISO/EN

m	11.0 m + 9.0 m			30.1 m + 9.0 m			41.6 m + 9.0 m			44.0 m + 9.0 m		
	0°	20°	40°	0°	20°	40°	0°	20°	40°	0°	20°	40°
3.0	10.5											
3.5	10.5											
4.0	10.5	10.5										
4.5	10.5	10.5		10.5								
5.0	10.5	10.5		10.5								
6.0	10.5	10.5	8.9	10.5								
7.0	10.5	9.9	8.5	10.5			6.0					
8.0	10.5	9.4	8.1	10.1	8.1		6.0			5.4		
9.0	10.4	8.9	7.8	9.6	7.7		6.0			5.4		
10.0	9.5	8.5	7.5	9.0	7.3	6.4	6.0			5.4		
11.0	8.7	8.2	7.2	8.5	7.0	6.1	6.0	5.4		5.4	5.1	
12.0	8.1	7.8	7.0	8.1	6.7	5.9	5.7	5.2		5.3	4.9	
14.0	7.1	7.2	6.7	7.3	6.2	5.5	5.2	4.9	4.4	4.9	4.6	4.3
16.0	6.3	6.8		6.7	5.8	5.2	4.8	4.5	4.2	4.5	4.3	4.0
18.0				6.0	5.4	4.9	4.4	4.3	3.9	4.2	4.0	3.8
20.0				5.3	5.1	4.7	4.1	4.0	3.7	3.8	3.8	3.6
22.0				4.4	4.7	4.5	3.8	3.7	3.5	3.6	3.5	3.4
24.0				3.7	3.9	4.1	3.6	3.5	3.4	3.3	3.3	3.2
26.0				3.1	3.3	3.4	3.2	3.3	3.2	2.9	3.0	3.0
28.0				2.5	2.7	2.8	2.7	2.9	3.0	2.6	2.7	2.7
30.0				2.1	2.2	2.3	2.2	2.4	2.5	2.2	2.4	2.4
32.0				1.7	1.8	1.8	1.9	2.0	2.1	1.8	2.0	2.1
34.0				1.4	1.4		1.5	1.7	1.7	1.5	1.6	1.7
36.0							1.2	1.4	1.4	1.2	1.3	1.4
38.0							1.0	1.1	1.1	1.0	1.1	1.1
40.0							0.8	0.8	0.8	0.7	0.8	0.9
42.0							0.6	0.6	0.6	0.5	0.6	0.6

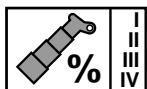

I
II
III
IV

0
0
0
0

93
46
46
46

93
93
93
93

100
100
100
100

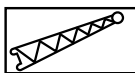
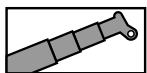

12.5t

'Taxi' Version

DIN/ISO/EN

m	11.0 m + 16.0 m			30.1 m + 16.0 m			41.6 m + 16.0 m			44.0 m + 16.0 m		
	0°	20°	40°	0°	20°	40°	0°	20°	40°	0°	20°	40°
3.0	7.9											
3.5	7.9											
4.0	7.9											
4.5	7.9											
5.0	7.9											
6.0	7.6			4.8								
7.0	7.2			4.8								
8.0	6.7	5.4		4.8			3.5					
9.0	6.3	5.1		4.8			3.5			3.3		
10.0	5.9	4.9		4.8			3.5			3.3		
11.0	5.6	4.7		4.8			3.5			3.3		
12.0	5.3	4.4	3.9	4.8	4.6		3.5			3.3		
14.0	4.7	4.1	3.7	4.8	4.4		3.5			3.3		
16.0	4.2	3.8	3.4	4.8	4.2	3.5	3.5	3.5		3.3		
18.0	3.7	3.5	3.3	4.8	4.0	3.4	3.5	3.3		3.3	3.1	
20.0	3.4	3.3	3.2	4.6	3.8	3.3	3.5	3.1		3.3	3.0	2.8
22.0	3.1	3.2	3.1	4.3	3.6	3.2	3.2	2.9	2.7	3.0	2.8	2.6
24.0	2.8	3.1		4.0	3.5	3.1	3.0	2.8	2.6	2.8	2.7	2.5
26.0				3.4	3.3	3.0	2.8	2.7	2.5	2.6	2.5	2.4
28.0				2.9	3.2	2.9	2.7	2.6	2.4	2.4	2.4	2.3
30.0				2.4	2.7	2.8	2.4	2.4	2.3	2.1	2.2	2.2
32.0				2.0	2.3	2.5	2.0	2.3	2.2	1.9	2.0	2.1
34.0				1.7	1.9	2.0	1.7	2.0	2.1	1.7	1.8	1.9
36.0				1.4	1.6	1.7	1.4	1.7	1.8	1.4	1.6	1.7
38.0				1.2	1.3	1.3	1.2	1.4	1.5	1.1	1.4	1.5
40.0				0.9	1.0		0.9	1.1	1.2	0.9	1.1	1.2
42.0				0.7	0.7		0.7	0.9	1.0	0.7	0.9	1.0
44.0							0.5	0.7	0.7	0.5	0.7	0.7
46.0								0.5	0.5	0.5	0.5	0.5

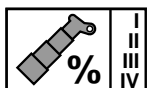

I
II
III
IV

0
0
0
0

93
46
46
46

93
93
93
93

100
100
100
100

Hubhöhen
Lifting heights
Hauteurs de levage
Alturas de elevación

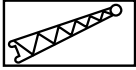
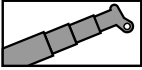

12.5t 'Taxi' Version

DIN/ISO/EN

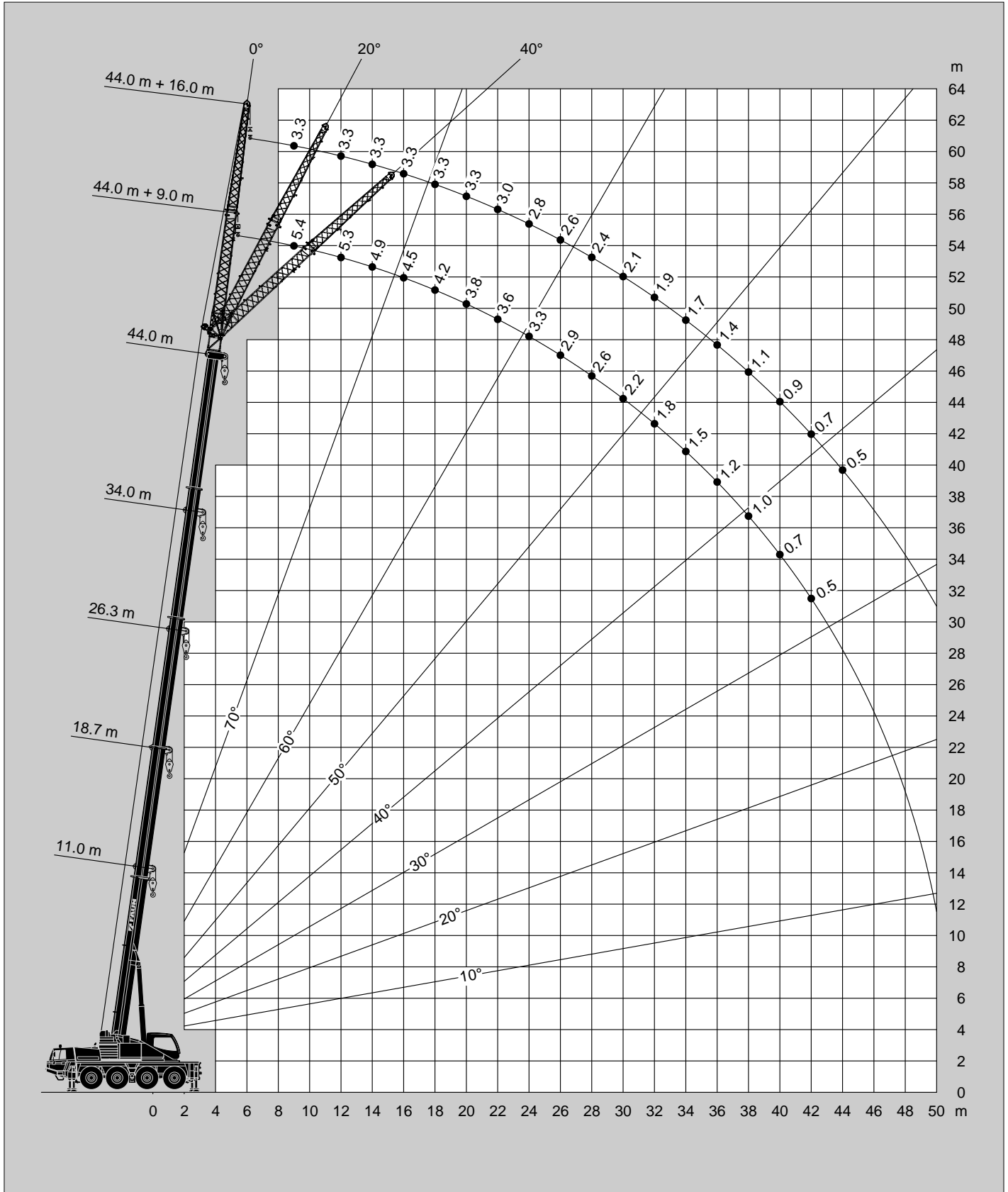

Tragfähigkeiten
Lifting capacities
Capacités de levage
Capacidades de elevación

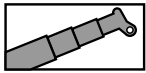

12.5t + **2.5t** Option = **15t**

DIN/ISO/EN

 m	11.0 m	14.8 m	18.7 m	22.5 m	26.3 m	30.1 m	34.0 m	37.8 m	41.6 m	44.0 m
2.5	65.0*									
3.0	53.3	50.0	40.0							
3.5	48.8	47.6	40.0	35.0						
4.0	44.8	44.1	40.0	34.9	30.0					
4.5	41.4	41.0	39.7	33.2	30.0	23.4				
5.0	38.5	38.3	37.0	32.0	30.0	22.2	18.5			
6.0	32.6	32.6	32.3	31.2	28.4	20.1	18.1	14.0		
7.0	27.7	27.9	27.9	27.6	26.0	18.3	16.6	14.0	10.4	9.2
8.0	23.5	24.1	24.2	23.9	23.9	16.8	15.3	14.0	10.4	9.2
9.0		21.2	21.2	20.9	21.1	15.4	14.1	13.1	10.4	9.2
10.0		18.2	18.3	18.9	18.6	14.3	13.1	12.2	10.4	9.2
11.0		16.0	16.4	16.3	16.0	13.2	12.2	11.4	10.4	9.2
12.0		14.1	14.4	14.4	14.1	12.3	11.4	10.7	9.9	9.0
14.0			11.4	11.4	11.1	10.7	10.0	9.4	8.9	7.8
16.0			9.2	9.2	8.9	8.6	8.7	8.4	7.9	6.8
18.0				7.6	7.3	7.2	7.8	7.3	7.1	6.0
20.0				6.6	6.1	6.6	6.5	6.5	6.2	5.3
22.0					5.4	5.8	5.5	5.5	5.2	4.7
24.0						5.0	4.8	4.7	4.4	4.2
26.0						4.3	4.1	4.0	3.8	3.7
28.0							3.6	3.5	3.2	3.2
30.0							3.1	3.0	2.7	2.8
32.0								2.6	2.3	2.3
34.0								2.2	2.0	2.0
36.0									1.7	1.7
38.0									1.4	1.4
40.0										1.2

 %	I	II	III	IV							
I	0	46/0/0/0	93/46/0/0/0/0	93/46/46/0/0	93/93/46/0	93/93/0	93/46/0	93/46	93	100	
II	0	0/46/0/0	0/46/93/46/0/0	46/93/46/46/0	93/46/46/0	93/46/46	93/46/93	93/93	93	100	
III	0	0/0/46/0	0/0/0/46/46/0	0/0/46/46/46	0/46/46/93	46/46/93	46/93/93	93/93	93	100	
IV	0	0/0/0/46	0/0/0/0/46/93	0/0/0/46/93	0/0/46/93	0/46/93	46/93/93	46/93	93	100	

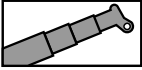

12.5t + 2.5t Option = 15t

DIN/ISO/EN

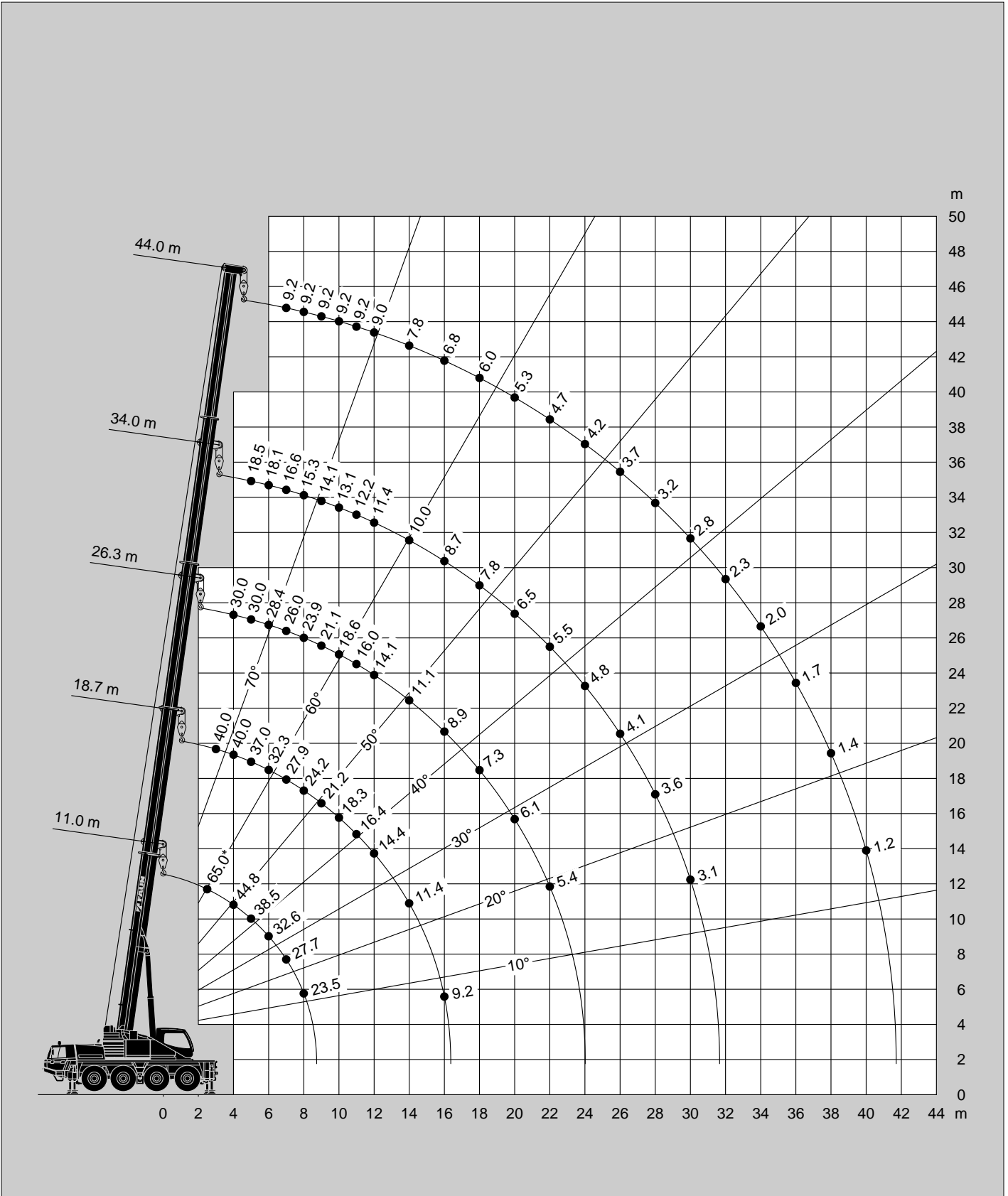

* Nach hinten mit Zusatzbausrüstung / * Over rear with additional lifting equipment / * A l'arrière avec équipement supplémentaire / * Sobre la parte trasera con equipo adicional

Tragfähigkeiten
Lifting capacities
Capacités de levage
Capacidades de elevación

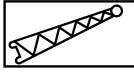
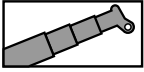

12.5t + **2.5t** = **15t**
Option

DIN/ISO/EN

m	11.0 m + 9.0 m			30.1 m + 9.0 m			41.6 m + 9.0 m			44.0 m + 9.0 m		
	0°	20°	40°	0°	20°	40°	0°	20°	40°	0°	20°	40°
3.0	10.5											
3.5	10.5											
4.0	10.5	10.5										
4.5	10.5	10.5		10.5								
5.0	10.5	10.5		10.5								
6.0	10.5	10.5	8.9	10.5								
7.0	10.5	9.9	8.5	10.5			6.0					
8.0	10.5	9.4	8.1	10.1	8.1		6.0			5.4		
9.0	10.4	8.9	7.8	9.6	7.7		6.0			5.4		
10.0	9.5	8.5	7.5	9.0	7.3	6.4	6.0			5.4		
11.0	8.7	8.2	7.2	8.5	7.0	6.1	6.0	5.4		5.4	5.1	
12.0	8.1	7.8	7.0	8.1	6.7	5.9	5.7	5.2		5.3	4.9	
14.0	7.1	7.2	6.7	7.3	6.2	5.5	5.2	4.9	4.4	4.9	4.6	4.3
16.0	6.3	6.8		6.7	5.8	5.2	4.8	4.5	4.2	4.5	4.3	4.0
18.0				6.0	5.4	4.9	4.4	4.3	3.9	4.2	4.0	3.8
20.0				5.4	5.1	4.7	4.1	4.0	3.7	3.8	3.8	3.6
22.0				4.8	4.8	4.5	3.8	3.7	3.5	3.6	3.5	3.4
24.0				4.3	4.4	4.3	3.6	3.5	3.4	3.3	3.3	3.2
26.0				3.6	3.8	4.0	3.2	3.3	3.2	2.9	3.0	3.0
28.0				3.1	3.2	3.4	2.9	3.0	3.0	2.6	2.7	2.7
30.0				2.6	2.8	2.8	2.6	2.7	2.8	2.3	2.4	2.4
32.0				2.2	2.3		2.3	2.4	2.5	2.0	2.2	2.2
34.0				1.9	1.9		2.0	2.1	2.2	1.8	1.9	2.0
36.0				1.6			1.6	1.8	1.9	1.6	1.7	1.8
38.0							1.4	1.5	1.6	1.3	1.5	1.5
40.0							1.1	1.2	1.3	1.1	1.2	1.3
42.0							0.9	1.0		0.9	1.0	1.0
44.0							0.7	0.8		0.7	0.8	
46.0							0.6	0.6		0.5	0.6	

%	I	II	III	IV
	0			93
	0			46
	0			46
	0			46
				93
				93
				93
				93

m	11.0 m + 16.0 m			30.1 m + 16.0 m			41.6 m + 16.0 m			44.0 m + 16.0 m		
	0°	20°	40°	0°	20°	40°	0°	20°	40°	0°	20°	40°
3.0	7.9											
3.5	7.9											
4.0	7.9											
4.5	7.9											
5.0	7.9											
6.0	7.6			4.8								
7.0	7.2			4.8								
8.0	6.7	5.4		4.8			3.5					
9.0	6.3	5.1		4.8			3.5			3.3		
10.0	5.9	4.9		4.8			3.5			3.3		
11.0	5.6	4.7		4.8			3.5			3.3		
12.0	5.3	4.4	3.9	4.8	4.6		3.5			3.3		
14.0	4.7	4.1	3.7	4.8	4.4		3.5			3.3		
16.0	4.2	3.8	3.4	4.8	4.2	3.5	3.5	3.5		3.3		
18.0	3.7	3.5	3.3	4.8	4.0	3.4	3.5	3.3		3.3	3.1	
20.0	3.4	3.3	3.2	4.6	3.8	3.3	3.5	3.1		3.3	3.0	2.8
22.0	3.1	3.2	3.1	4.3	3.6	3.2	3.2	2.9	2.7	3.0	2.8	2.6
24.0	2.8	3.1		4.1	3.5	3.1	3.0	2.8	2.6	2.8	2.7	2.5
26.0				3.7	3.3	3.0	2.8	2.7	2.5	2.6	2.5	2.4
28.0				3.4	3.2	2.9	2.7	2.6	2.4	2.4	2.4	2.3
30.0				2.9	3.0	2.8	2.5	2.4	2.3	2.1	2.2	2.2
32.0				2.5	2.8	2.7	2.2	2.3	2.2	1.9	2.0	2.1
34.0				2.1	2.4	2.6	2.0	2.2	2.1	1.7	1.8	1.9
36.0				1.8	2.0	2.2	1.8	2.0	2.0	1.5	1.6	1.7
38.0				1.6	1.7		1.5	1.8	1.9	1.4	1.5	1.5
40.0				1.3	1.5		1.3	1.5	1.7	1.2	1.3	1.4
42.0				1.1	1.2		1.1	1.3	1.4	1.0	1.2	1.3
44.0							0.9	1.1	1.2	0.8	1.0	1.1
46.0							0.7	0.8	0.9	0.6	0.8	0.9
48.0										0.5	0.6	0.7
50.0												

%	I	II	III	IV
	0			93
	0			46
	0			46
	0			46
				93
				93
				93
				93

Hubhöhen
Lifting heights
Hauteurs de levage
Alturas de elevación

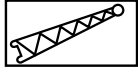
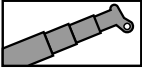

12.5t + 2.5t Option = 15t

DIN/ISO/EN

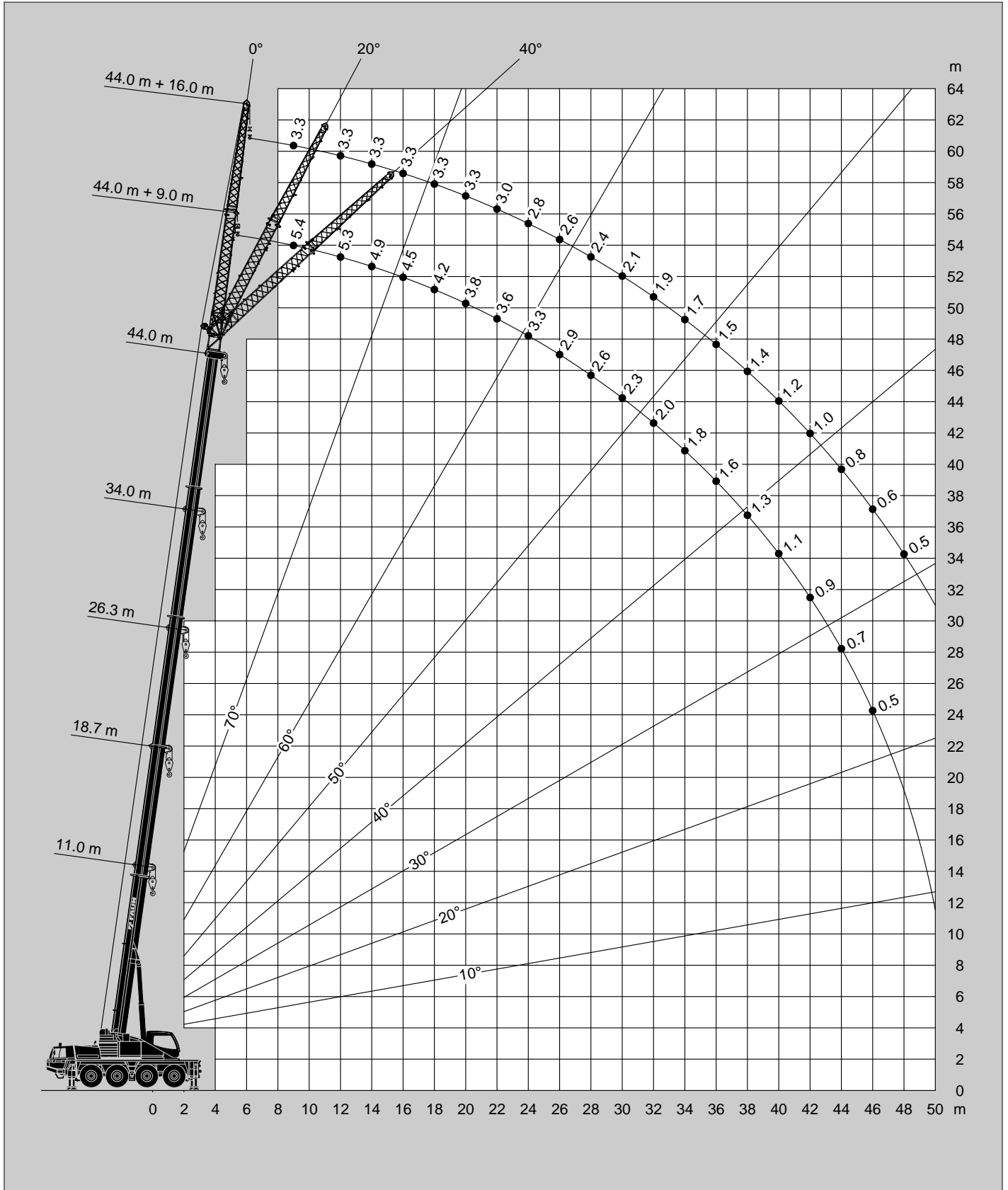

Anmerkungen zu den Traglasttabellen

Die Tragfähigkeiten im Festigkeitsbereich basieren auf DIN 15018 Blatt 2 und Blatt 3 und F.E.M.

Die Tragfähigkeiten im Standsicherheitsbereich entsprechen DIN 15019 Teil 2 / ISO 4305 / EN 13000.

Die zulässige Windgeschwindigkeit beträgt maximal 15 m/sec.

Die Tragfähigkeiten sind in metrischen Tonnen angegeben.

Das Gewicht des Lasthakens bzw. der Hakenflasche und weiterer Anschlagmittel ist von der Tragfähigkeit abzuziehen.

Die Tragfähigkeiten für den Teleskopausleger gelten nur bei demonstrierter Spitze.

Die Ausladung ist der horizontale Abstand von Mitte Drehkranz bis Mitte freihängender, nicht schwingender Last.

Tragfähigkeitsänderungen vorbehalten.

Obige Angaben dienen nur zur Information. Die Bedienungsanleitungen müssen zu Rate gezogen werden, bevor die Maschine in Betrieb genommen wird. Alle hier gemachten Angaben beziehen sich auf die Standard-Ausführung. Jegliche Ausrüstungsveränderungen können die angegebenen Werte beeinflussen.

Remarks relating to the rating charts

The lifting capacities in the structural area are based on DIN 15018 parts 2 and 3 and F.E.M.

The lifting capacities in the stability area are based on DIN 15019 part 2 / ISO 4305 / EN 13000.

The maximum permissible wind speed for crane operation is 15 m/sec.

The lifting capacities shown are in metric tons.

The weight of load handling devices such as hook blocks, slings, etc., must be considered as part of the load and must be deducted from the lifting capacities.

The lifting capacities for the telescopic boom apply to a crane with no boom extensions being stowed or mounted on the crane.

The working radius is the horizontal distance from the centre of rotation to the centre of the freely suspended non-oscillating load.

The lifting capacities are subject to change without prior notice.

The above remarks are for basic information only and the operator's manual must be consulted before operating this crane. All data and performances refer to the standard crane. The addition of optional and other equipment may affect the performance of the crane.

Remarques relatives aux tableaux des charges

Les forces de levage sont conformes aux normes DIN 15018, p. 2 et 3, et F.E.M.

Les forces de levage dans la partie de stabilité au renversement sont conformes aux normes DIN 15019, chap. 2 / ISO 4305 / EN 13000.

La grue peut travailler aux vitesses de vent allant jusqu'à 15 m/s.

Les forces de levage sont données en tonnes métriques.

Le poids du crochet-moufle et de tous les accessoires d'élingage font partie de la charge et sont à déduire des charges indiquées.

Les forces de levage indiquées pour la flèche télescopique s'entendent fléchette déposée.

Comme portée, on entend la distance horizontale du centre de la couronne de rotation au centre de la charge librement suspendue et non oscillante.

Sauf modification de forces de levage.

Les données ci-dessus servent à titre d'information. Avant la mise en marche de la grue il est conseillé d'étudier les instructions de service. Toutes les données indiquées ci-dessus se réfèrent à la machine de base. Tout changement de l'équipement de la grue peut influencer ces valeurs.

Notas relativas a los graficos de carga

En cuanto a los datos referentes a resistencia, las capacidades de carga están basados sobre las normas DIN 15018, pág. 2 y 3, y F.E.M.

En cuanto a los datos referentes a estabilidad anti-vuelco, las capacidades de carga están basados sobre las normas DIN 15019, Cap. 2 / ISO 4305 / EN 13000.

La velocidad anemométrica max. admisible es de 15 m/seg.

Las capacidades de carga indicadas en las tablas corresponden a toneladas métricas.

Hay que deducir los pesos del gancho, eslingas y de otros dispositivos para fijación de cargas de los valores indicados en las tablas.

Las capacidades de carga referentes a la pluma telescópica valen solamente si el plumín está desmontada.

Como alcance se entiende la distancia horizontal desde el centro de la corona de giro hasta el centro de la carga suspendida libremente y no oscilante.

Salvo modificación de capacidades de carga, sin previo aviso.

Los datos arriba indicados sirven solamente para su información. Hay que leer las instrucciones para el uso antes de la puesta en servicio de la máquina. Todos los datos mencionados en las presentes tablas rigen para los modelos standard. Cualquier modificación del equipo montado puede dar lugar a modificaciones de aquellos valores.

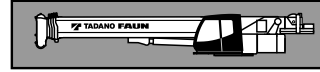
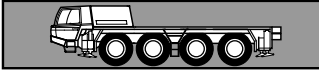

Rahmen Verwindungs- und biegesteife Schweißkonstruktion aus hochfestem Feinkornstahl.

Abstützung 4-Punkt-Abstützung, hydraulisch, Bedienungsmöglichkeiten an beiden Seiten des Fahrgestelles und in der Oberwagenkabine.
Abstützbasis 6,4 m (und 4,4 m) x 7,8 m.

Motor Mercedes-Benz 6-Zylinder-Dieselmotor OM 501 LA (Euromot III A/EPA III), wassergekühlt, Leistung 290 kW (394 PS) bei 1800 min⁻¹. Drehmoment 1850 Nm (189 kpm) bei 1300 min⁻¹. Motorleistung nach 80/1269/EWG. Kraftstoffbehälter 330 l.

Getriebe ZF-AS-Tronic 12 AS 2302 mechanisches Schaltgetriebe mit elektronisch-pneumatisch betätigter Trockenkupplung und vollautomatischer Schaltung mit 12 Vorwärts- und 2 Rückwärtsgängen. Power/Economy Modus.

Verteilergetriebe 2-stufig.

Antrieb 8 x 6 (8 x 8 Option).

Achsen

1. Achse: gelenkt, nicht angetrieben.
2. Achse: gelenkt, angetrieben, Differentialsperre quer.
3. Achse: gelenkt, angetrieben, Differentialsperre längs und quer.
4. Achse: gelenkt, angetrieben, Differentialsperre quer.

Achsaufhängung Hydropneumatische Federung mit Niveauregulierung.

Bremsen Druckluft-Zweikreis-Bremsanlage mit ABS System. Feststellbremse als Federspeicherbremse an der 2., 3. und 4. Achse wirkend. Intarder und Dauerbremse als Konstantdrosselanlage mit Auspuffklappenbremse.

Räder 8-fach 14.00 R 25 (385/95 R 25), (Breite 2.55).

Lenkung ZF-Servocom-Zweikreis-Hydraulenlenkung. Mechanische Lenkung der 1. und 2. Achse und Mitlenken der 4. Achse (bis zu einer Geschwindigkeit von 25 km/h), hydraulisch unterstützt, mit Notlenkpumpe. Lenkung aller Achsen möglich. Hydrostatische Lenkung aller Achsen aus der Oberwagenkabine.

Unterwagenkabine Zwei-Mann-Frontfahrerhaus in Stahl-Kunststoff-Verbund-Konstruktion, Sicherheitsverglasung, luftgefederte Sitze und motorabhängige Warmwasserheizung, Kontroll- und Bedienungselemente für den Fahrbetrieb. Tempomat / Bremsomat-Funktion.

Elektrische Anlage 24 Volt-Gleichstrom, 2 Batterien, Abstützbeleuchtung.
Die elektrische Anlage entspricht der EG-Norm.

Zusatzrüstung (gegen Mehrpreis)
Anhängerkupplung, motorunabhängige Zusatzheizung mit Motorvorwärmung, Klimaanlage, 8 x 8 Antrieb, 16.00 R 25 (445/95 R 25), 20.5 R 25 (525/80 R 25) Bereifung, Reserverad, Sonderlackierung und Beschriftung.

Weitere Zusatzrüstung auf Anfrage.

Rahmen Verwindungssteife Schweißkonstruktion mit einer außenverzahnten, einreihigen Kugeldrehverbindung, um 360° unbegrenzt drehbar.

Motor Mercedes-Benz 4-Zylinder-Dieselmotor OM 904 LA (Euromot III A/EPA III), wassergekühlt. Drehzahl über Fußpedal stufenlos regelbar, Leistung 90 kW (122 PS) bei 2200 min⁻¹. Drehmoment 470 Nm (48 kpm) bei 1200 - 1600 min⁻¹. Motorleistung nach DIN 6270B/DIN 6271. Kraftstoffbehälter 200 l.

Hydraulik System Diesel-hydraulisch mit 3-Kreis-Hydraulik, 1 leistungsgeregelte Axialkolbendoppelpumpe (hydraulisch verstellbar) und 1 Zahnrad-Doppelpumpe.

Steuerung Zwei 4-fach Kreuzsteuerhebel mit elektrischer Vorsteuerung.

Teleskopausleger Fünfteiliger Teleskopausleger aus hochfestem Feinkornstahl, bestehend aus einem Grundaussleger und 4 Teleskopteilen, 1 Teleskopzylinder, hydraulisch unter Teillast teleskopierbar. 11,0 m - 44,0 m lang.

Wippwerk Differentialzylinder mit angebautelem Senkbremssperrventil.

Hubwerk Axialkolben-Motor, Hubwerkstrommel mit eingebautem Planetengetriebe und federbelasteter Hydro-Lamellenbremse mit integriertem Freilauf beim Heben. Hubseil mit 'Super-Stop' Einrichtung.

Drehwerk Axialkolben-Motor, zweistufiges Planetengetriebe mit fußbetätigter Betriebsbremse und Feststellung. Drehgeschwindigkeit stufenlos von 0 - 2 min⁻¹.

Gegengewicht Standard 'Taxi' 12,5 t teilbar. Die Bedienung erfolgt aus der Oberwagenkabine.

Oberwagenkabine Großräumige Krankabine in Stahl-Kunststoff-Ausführung mit Sicherheitsverglasung mit getönten Scheiben, kippbarem Arbeitsplatz mit verstellbarem, gefederten, gedämpftem Fahrersitz, motorunabhängige Warmwasserheizung, Kontroll- und Bedienungselemente für Kranbetrieb, Verfahrbarkeit vom Oberwagen und Abstützbetätigung.

Elektrische Anlage 24 Volt-Gleichstrom, 2 Batterien.

Sicherheitseinrichtungen Lastmomentbegrenzung (LMB), Arbeitsbereichsbegrenzung, Hubendschalter, Windenendschalter, Seilwindendrehmelder, Sicherheitsventile gegen Rohr- und Schlauchbrüche. Sperrventile an Hydraulik-Zylindern.

Zusatzrüstung (gegen Mehrpreis)
'Lift Adjuster', Auslegerverlängerung 9,0 m / 16,0 m abwinkelbar 0°, 20° und 40°, Schwerlastspitze 1,6 m, Zusatzgegengewicht 2,5 t, verschiedene Unterflaschen, 2. Hubwerk, Drehbereichsbegrenzung, motorunabhängige Heizung mit Motorvorwärmung, Klimaanlage, Sonderlackierung und Beschriftung.

Weitere Zusatzrüstung auf Anfrage.

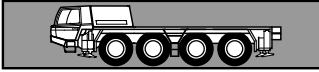

Frame Torsion resistant, welded construction made from high strength, fine-grained steel.

Outriggers 4 point, telescopic hydraulic outriggers with controls on both sides of carrier and in superstructure cab. Outrigger base 6.4 m (4.4 m mid extension) x 7.8 m.

Carrier engine Mercedes-Benz 6 cylinder model OM 501 LA (Euromot III A/EPA III), water-cooled diesel engine. Rated at 290 kW (394 HP) at 1800 min⁻¹. Torque 1850 Nm (189 kpm) at 1300 min⁻¹. Engine rating according to 80/1269/EWG. Fuel tank 330 l.

Transmission ZF-AS-Tronic 12 AS 2302 mechanical transmission with electro-pneumatically operated dry-type clutch and automatic gear shifting with 12 forward gears and 2 reverse gears. Power/Economy mode.

Transfer Case Two stage.

Drive 8 x 6 (8 x 8 option).

Axles

- 1st axle: steered, not driven.
- 2nd axle: steered, driven, with differential lock, transverse.
- 3rd axle: steered, driven, with differential locks longitudinal and transverse.
- 4th axle: steered, driven, with differential lock, transverse.

Suspension Hydro-pneumatic with levelling adjustment.

Brake system Service brakes: dual circuit compressed air system with ABS. Parking brake: spring loaded type acting on 2nd, 3rd and 4th axles. Auxiliary brakes: intarder, engine exhaust brake and constant throttle engine brake system.

Tyres (8) 14.00 R 25 (385/95 R 25), (width 2.55 m).

Steering system ZF-Servocom, dual circuit hydraulic steering, mechanical hydraulically-assisted steering of front two axles and automatic steering of the 4th axle (up to a travel speed of 25 km/h), emergency steering pump. Steering of all axles possible. All axles steered hydrostatically from superstructure cab.

Carrier cab Two man full width cab of composite (steel sheet metal and fibre-glass) structure, with safety glass, air-cushioned adjustable seats, engine dependent hot-water heater. Complete controls and instrumentation for road travel. Speed and brake control.

Electrical system 24 volt DC system, 2 batteries, outrigger lighting. Electrical system conforms with EEC regulations.

Optional Equipment (at extra charge)
Towing attachment, engine independent additional heater with engine pre-heat, air conditioning, 8 x 8 drive, 16.00 R 25 (445/95 R 25), 20.5 R 25 (525/80 R 25) tyres, spare wheel and tyre, special painting and lettering.

Further optional equipment available upon request.

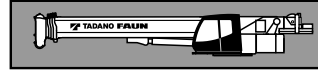

Frame Torsion-resistant, all-welded structure of high strength steel. Connected to carrier by single-row ball-bearing slewing ring with external gearing for 360° continuous rotation.

Superstructure engine Mercedes-Benz 4 cylinder model OM 904 LA (Euromot III A/EPA III), water cooled, diesel engine. PRM infinitely variable via foot pedal, rating 90 kW (122 HP) at 2200 min⁻¹. Torque 470 Nm (48 kpm) at 1200 - 1600 min⁻¹. Engine rating according to DIN 6270B/DIN 6271. Fuel tank 200 l.

Hydraulic system Three circuit diesel hydraulic system with 1 power controlled axial piston double pump (hydraulically adjustable) and 1 double gear pump.

Controls Electrical, 2 joy-stick levers for simultaneous operation of crane motions.

Telescopic boom 5 sections, made of high tensile, fine-grained steel, consisting of 1 base section and 4 telescoping sections extended by means of a single telescopic cylinder. All telescope sections extendable under partial load. 11.0 m to 44.0 m long.

Derricking system 1 double acting hydraulic cylinder with integral brake and holding valve.

Main winch Axial piston motor, winch drum with integrated planetary reduction and with hydraulically controlled spring-loaded, multiple disc brake and with integrated free rotation (no sagging of load when hoisting). Hoist cable with 'Super-Stop' easy reeving system.

Slewing system Axial piston motor with two-stage planetary reduction with a foot actuated service and a parking brake. Speed infinitely variable 0 - 2 min⁻¹.

Counterweight Standard 'Taxi' 12.5 t divisible, assembled and disassembled by hydraulic cylinders controlled from superstructure cab.

Superstructure cab Spacious panoramic cab of composite structure with safety (tinted) glass windows, tiltable cockpit with hydraulically cushioned adjustable seat, engine independent hot-water heater. Complete controls and instrumentation for crane operation, on-site travelling and outriggers.

Electrical system 24 volt DC system, 2 batteries.

Safety devices Load moment device (LMD), working area limiter, hoist limit switch, lower limit switch and drum turn indicator, safety valves against pipe and hose rupture. Holding valves on hydraulic cylinders.

Optional Equipment (at extra charge)
'Lift Adjuster', boom extension 9.0 m / 16.0 m offsets 0°, 20° and 40°, heavy duty jib 1.6 m, additional counterweight 2.5 t, selection of hook blocks, auxiliary winch, slewing area limitation, engine independent heater with engine pre-heat, air conditioning, special painting and lettering.

Further optional equipment available upon request.

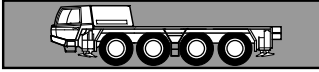

Châssis Construction mécano-soudée, en acier fin, résistante aux flexions et aux torsions.

Calage Calage à 4 points, complètement hydraulique. Commande des stabilisateurs des deux côtés du châssis et de la cabine du grutier. Calage 6,4 m (aussi 4,4 m) x 7,8 m.

Moteur Mercedes-Benz diesel 6 cylindres, modèle OM 501 LA (Euromot III A/EPA III), refroidi par eau, de 290 kW (394 CV) à 1800 min⁻¹. Couple: 1850 Nm (189 kpm) à 1300 min⁻¹. Puissance selon 80/1269/EWG. Dépósito de combustible 330 l.

Boîte de vitesse Boîte mécanique ZF-AS-Tronic, modèle 12 AS 2302 avec embrayage électro-pneumatique réglé à commande et boîte automatique, 12 vitesses AV et 2 vitesses AR. Mode max. performance / économique.

Boîte de transfert À 2 gammes.

Entraînement 8 x 6 (8 x 8 option).

Essieux

1^{er} essieu: directeur, non entraîné.

2^{ème} essieu: directeur, entraîné, blocage de différentiel transversal.

3^{ème} essieu: directeur, entraîné, blocage de différentiel longitudinal et transversal.

4^{ème} essieu: directeur, entraîné, blocage de différentiel transversal.

Suspension Hydro-pneumatique, avec réglage de niveau.

Freins Système à air comprimé, à double circuit avec système ABS. Frein de stationnement: avec accumulateurs à ressort agissant sur le 2^{ème}, 3^{ème} et 4^{ème} essieu. Intarder, frein continu: Frein sur échappement avec étrangleur.

Pneus 8 x 14.00 R 25 (385/95 R 25), (largeur 2,55 m).

Direction Servocom à double circuit, marque ZF. Direction mécanique du 1^{er} et 2^{ème} essieu, à assistance hydraulique, avec pompe de direction auxiliaire direction du 4^{ème} essieu (jusqu'à une vitesse de 25 km/h), avec pompe de direction auxiliaire. Direction de tous les essieux possible. Direction hydro-statique de tous les essieux depuis la cabine du grutier.

Cabine Cabine bi-place, construction en matière composite fibre de verre et acier. Vitrage en verre de sécurité, sièges à suspension pneumatique. Chauffage à eau chaude relié au moteur. Organes de contrôle et de commande pour la conduite. Régulateur de vitesse, système automatique de freinage.

Système électrique 24 V courant continu, 2 batteries, illumination des calages. Conforme aux normes CE.

Équipement supplémentaire (avec supplément de prix) Attache-remorque, chauffage auxiliaire indépendant du moteur avec préchauffage du moteur, climatisation, Entraînement 8 x 8, pneus 16.00 R 25 (445/95 R 25), 20.5 R 25 (525/80 R 25), roue de secours, peinture spéciale et inscription.

Autres équipements supplémentaires sur demande.



Plate forme Construction mécano-soudée résistante à la torsion. Couronne d'orientation à billes à une rangée, à denture extérieure, permettant une rotation illimitée sur 360°.

Moteur Mercedes-Benz diesel 4 cylindres, modèle OM 904 LA (Euromot III A/EPA III), refroidi par eau, Réglage du nombre de tours par pédale, de 90 kW (122 CV) à 2200 min⁻¹. Couple: 470 Nm (48 kpm) à 1200 - 1600 min⁻¹. Puissance selon DIN 6270B/DIN 6271. Dépósito de combustible 200 l.

Système hydraulique Diesel-hydraulique à 3 circuits, 1 double pompe à pistons axiaux à régulation de puissance (à réglage hydraulique) et 1 pompe à engrenages.

Commande 2 manipulateurs à commande en croix (4 sens), assistés électriquement.

Flèche télescopique 1 flèche de base et 4 éléments télescopiques en acier fin, 1 vérin télescopique, hydrauliquement télescopable avec charge partielle. Longueur 11,0 m à 44,0 m.

Mécanisme de relevage 1 vérin différentiel muni de clapet de freinage de descente.

Mécanisme de levage Moteur hydraulique, tambour de levage avec boîte planétaire incorporée, frein d'arrêt à disques multiples à ressort, libéré lors du levage. Câble de levage avec dispositif 'Super-Stop'.

Orientation Moteur hydraulique avec entraînement planétaire à 2 gammes. Frein de service actionné par l'intermédiaire d'une pédale et frein de stationnement. Vitesse de rotation 0 à 2 min⁻¹ en continu.

Contrepoids Standard 'Taxi' 12,5 t divisible, commandé depuis la cabine du grutier.

Cabine du grutier Cabine de grue spacieuse, construction en matière combinée acier/synthétique, avec vitrage de sécurité en verre teinté, siège réglable et amorti hydrauliquement, inclinable avec instruments de commande, chauffage à eau chaude indépendant du moteur, éléments de commande et de contrôle pour travaux sur chantier, conduite et calage de la grue depuis la cabine du grutier.

Système électrique 24 V courant continu, 2 batteries.

Dispositifs de sécurité Limiteur de charge (CEC), limitation de zone de travail, interrupteur de fin de course de levage et de treuil, indicateur du nombre de tours, soupapes de sécurité contre ruptures des conduites et flexibles, clapets sur verins hydrauliques.

Équipement supplémentaire (avec supplément de prix) 'Lift Adjuster', fléchette 9,0 m / 16,0 m inclinable 0°, 20° et 40°, fléchette pour levage lourde 1,6 m, contrepoids additionnel de 2,5 t, sélection de moufles, 2^{ème} treuil de levage, limitation de rotation, chauffage auxiliaire avec préchauffage du moteur, climatisation, peinture spéciale et inscription.

Autres équipements supplémentaires sur demande.

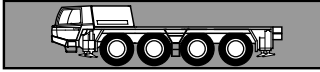

Chasis portante Construcción de acero de alta resistencia soldado, resistente a la torsión y a la flexión.

Estabilizadores Estabilizadores hidráulicos de 4 puntos. Posibilidad de manejo desde ambos lados del chasis portante y desde la cabina de la grúa. Extensión de los estabilizadores: 6,4 m (y 4,4 m) x 7,8 m.

Motor Mercedes-Benz modelo OM 501 LA (Euromot III A/EPA III), 6 cilindros, diesel, refrigerado por agua. Nominal 290 kW (394 HP) a 1800 min⁻¹. Par 1850 Nm (189 kpm) a 1300 min⁻¹. Potencia del motor según 80/1269/EWG. Réservoir à carburant 330 l.

Transmisión Transmisión mecánica tipo ZF-AS Tronic modelo 12 AS 2302 con accionamiento electro - neumáticamente embrague en seco y cambio automático 12 marchas delanteras y 2 marchas traseras. Modo rendimiento máximo/económico.

Transmisión Caja de distribución de dos escalones.

Tracción 8 x 6 (8 x 8 opción).

Ejes

- 1º eje: de dirección, no accionado.
- 2º eje: de dirección, accionado, con bloqueo diferencial transversal.
- 3º eje: de dirección, accionado, con bloqueo diferencial transversal y longitudinal.
- 4º eje: de dirección, accionado, con bloqueo diferencial transversal.

Suspensión Suspensión hidroneumática con regulación de nivel.

Sistemas de frenos Accionamiento neumático de doble circuito con sistema anti bloqueo ABS. Freno de estacionamiento del tipo muelles cargados, liberados por aire, sobre los ejes 2º, 3º y 4º. Intarder y freno continuo: sistema estrangulador constante y freno tipo estrangulación sobre el escape del motor diesel.

Neumáticos 8 x 14.00 R 25 (385/95 R 25), (ancho 2,55 m).

Dirección Hidráulica ZF Servocom de doble circuito. Dirección mecánica del 1º y 2º eje y direccionable del 4º eje (hasta una velocidad de 25 km/h), con bomba hidráulica de emergencia accionada por la transmisión. Dirección de todos los ejes posible. Desde la cabina de la superestructura: dirección hidro-estática de ambos ejes.

Cabina Cabina para dos personas, en construcción de acero y fibra de vidrio. Cristales de seguridad, asiento con suspensión neumática, calefacción por agua caliente del motor. Elementos de control e instrumentos para circulación por carretera. Regulador de velocidad, sistema automático de frenado.

Sistema eléctrico Sistema de 24 V c.c. con 2 baterías, faros en gatos. El sistema eléctrico cumple la normativa CEE.

Equipo adicional (con suplemento de precio) Embrague de remolque, calefacción adicional con precalefacción del motor, climatización, Tracción 8 x 8, neumáticos 16.00 R 25 (445/95 R 25), 20.5 R 25 (525/80 R 25), rueda de repuesto, pintura especial e inscripción.

Otros equipamientos sobre demanda.



Superestructura Construida en aceros soldados, resistente a la torsión. Corona de giro con rodamiento de una fila de bolas con dientes externos para giro continuo de 360°.

Motor Mercedes-Benz modelo OM 904 LA (Euromot III A/EPA III), 4 cilindros, diesel, refrigerado por agua. Las revoluciones aumentan de forma gradual accionado el acelerador. Nominal 90 kW (122 HP) a 2200 min⁻¹. Par 470 Nm (48kpm) a 1200 - 1600 min⁻¹. Potencia del motor según DIN 6270B/DIN 6271. Réservoir à carburant 200 l.

Sistema hidráulico Sistema hidráulico de 3 circuitos, 1 bomba doble de pistones axiales de caudal variable (regulable hidráulicamente) y una bomba de engranajes.

Mandos 2 palancas de control de tipo joy-stick para movimientos simultáneos de la grúa (4 direcciones), asistidos eléctricamente.

Pluma telescópica 5 secciones, un tramo base y 4 telescópicos de acero de alta resistencia soldado, 1 cilindro hidráulico, los tramos se pueden telescopar hidráulicamente bajo carga. Longitud de 11,0 m a 44,0 m.

Elevación de pluma Mediante un cilindro hidráulico con válvula de retención integrada.

Cabrestante principal Motor hidráulico de pistones axiales. Tambor del cabrestante con reducción planetaria y frenos de disco múltiples accionado, con sistema libre de elevación. Cable de elevación con sistema de enhebrado fácil y 'Super-Stop'.

Sistema de giro Motor hidráulico de pistones axiales con reducción planetaria de dos etapas. Freno de servicio controlado por pedal y freno de estacionamiento. Velocidad de giro variable de 0 a 2 min⁻¹.

Contrapeso El estándar 'Taxi' 12,5 t divisible, accionado desde la cabina de la grúa.

Cabina de la grúa Cabina espaciosa y confortable, en construcción de acero y fibra de vidrio, con cristales coloreados de seguridad. Asiento del operador regulable amortiguado hidráulicamente, inclinable junto con los instrumentos y mandos, calefacción por agua caliente independiente del motor. Controles, instrumentos y mandos de conducción para la operación de la grúa y para el desplazamiento en obra. Mandos para nivelación y extensión de los estabilizadores.









Sistema eléctrico Sistema de 24 V c.c. con 2 baterías.



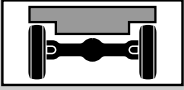

Medidas de seguridad Limitación del momento de carga (LMC), limitación del área de trabajo, interruptor de final de elevación, interruptor de 3 últimas vueltas en cabrestante, indicador de bajada o subida del cable del cabrestante, válvulas de seguridad para rotura de tubos y latiguillos. Válvulas de retención en los cilindros hidráulicos.

Equipo adicional (con suplemento de precio) 'Lift Adjuster', plumín de 9,0 m/16,0 m acodable 0°, 20° y 40°, plumín de carga pesada de 1,6 m, contrapeso suplementario de 2,5 t, selección de ganchos, 2º cabrestante, limitador de giro, calefacción independiente del motor y precalefacción del motor, climatización, pintura especial e inscripción.

Otros equipamientos sobre demanda.

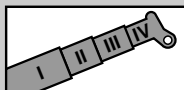
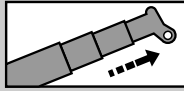
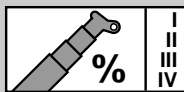
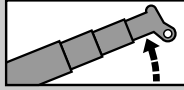
Symbolerklärung Symbols Glossaire des symboles Glosario de simbolos

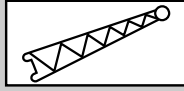
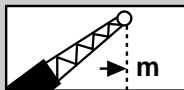
DIN/ISO/EN	Siehe Seite 12 As on Page 12 Voyez la page 12 Véase la pagina 12
	Abstützung Outriggers Calage Estabilizadores
	Getriebe / Gang Transmission / Gear Boîte de vitesse / Rapport Transmisión / Marchas
	Achslast Axle load Charge à l'essieu Carga por eje
 16.00 (445/95)	Räder / Größe Tyres / Size Pneus / Largeur Neumáticos / Tamaño de ruedas
	Gelände Off road Tout-terrain Todo terreno
	Straße On road En route En carretera
V+	Geschwindigkeiten Speeds Vitesses Velocidades
	Steigfähigkeit Gradeability Abtitude en pente Superacion de pendientes
	Drehwerk Slewing system Orientation Sistema de giro
12.5t	Gegengewicht Counterweight Contrepoids Contrapeso

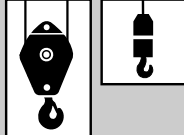
	Teleskopausleger Telescopic boom Flèche télescopique Pluma telescópica
	Teleskopieren Boom telescoping Télescopage de flèche Telescopaje de pluma
	Teleskopieren in % Boom telescoping in % Télescopage de flèche en % Telescopaje de pluma en %
	Wippwerk Derricking system Mécanisme de relevage Elevación de pluma
	Ausladung Radius Portée Radio
	Auslegerverlängerung Boom extension Fléchette Plumín
	Ausladung Radius Portée Radio
	Hubwerk Main winch Mécanisme de levage Cabrestante principal
	2. Hubwerk Auxiliary winch 2ème treuil de levage 2º cabrestante
	Unterflasche / Hakengeschrir Hook block / Swivel hook Moufle / Elingues Gancho / Gancho de bola